

Safe and easy to use,  
this is Japan's standard model



Woody BR

Whitey BR



Wooden Board

Wooden Shelf Board



Patent No. 5089786  
(Control Switch Shape)

## Function

### 2 Motors



BACK RAISING  
70°



BACK & KNEE  
70°/22°



HEIGHT  
ADJUSTABLE



### 3 Motors



BACK RAISING  
70°



BACK & KNEE  
70°/18°



KNEE RAISING  
18°



HEIGHT  
ADJUSTABLE



# Features

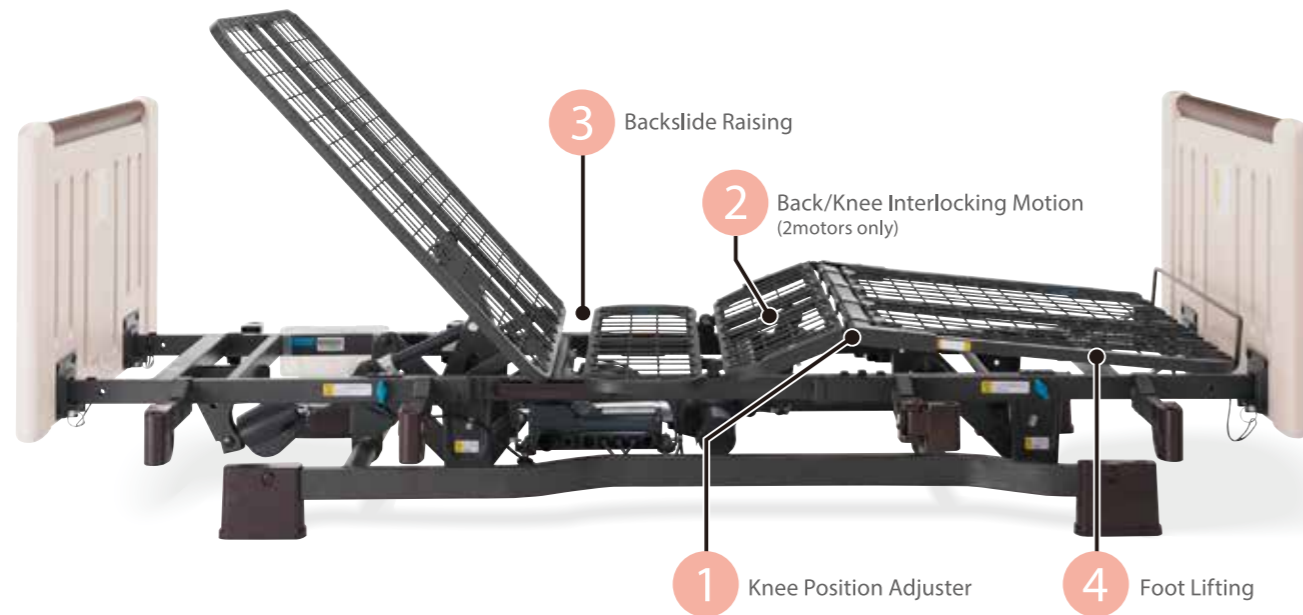

Equipped with Highly-Functional Motor from LINAK in Denmark

Miolet II's motor is quiet and water resistant (IPX4)\*  
\*IPX4 indicates the waterproof protection standard against spraying water at all angles



## 1 Knee position adjuster to reduce slippage during reclining

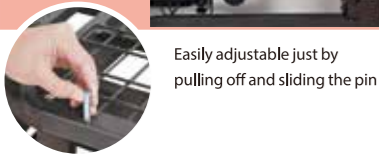

## 2 Back/Knee Interlocking Motion

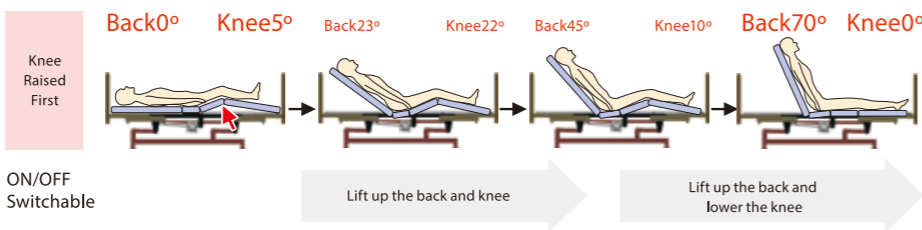

## 3 Backslide Raising

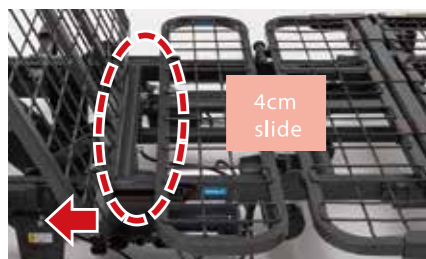

## 4 Swollen reduction by foot lifting function



# Universal Design Control Switch

Easy to Hold and Use Universal Design Control Switch

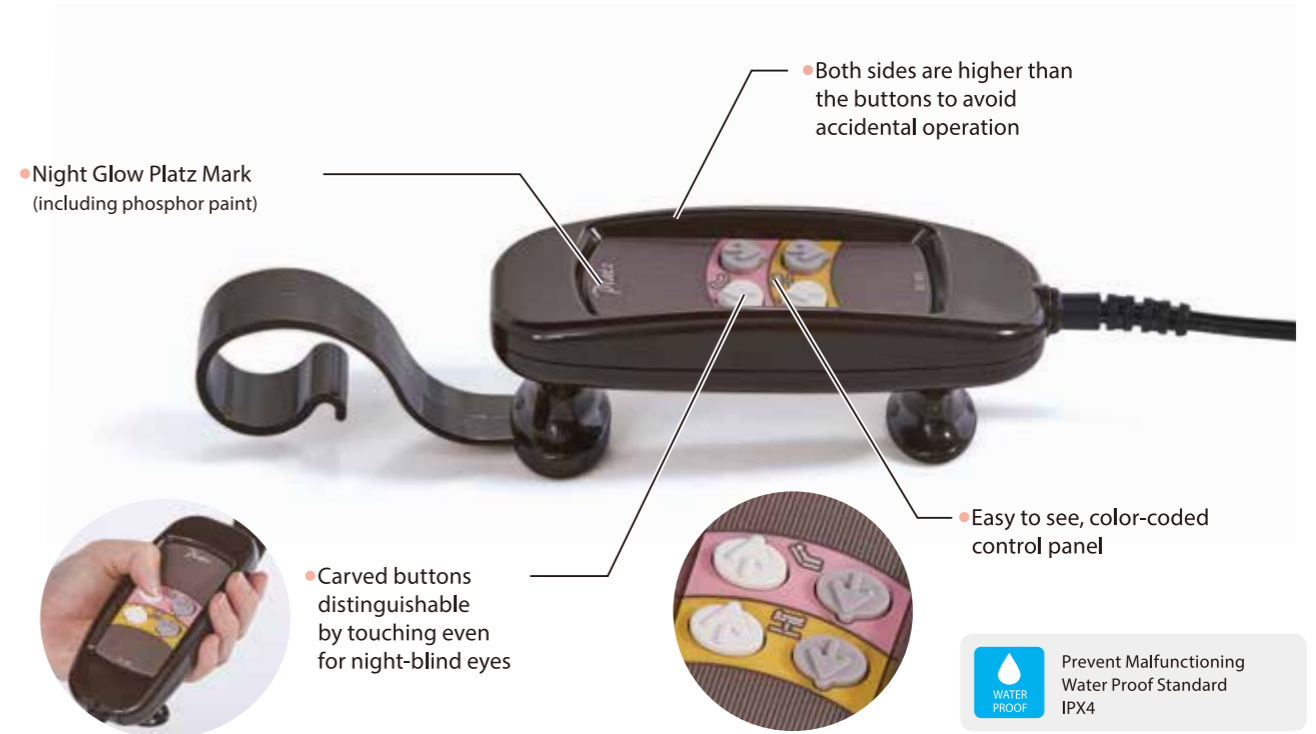

## Easy to operate with a weak grip



## Easy to hang on the side rails



# Unique Japan-made with Delicate Care

Unique Japan-made with delicate care reduces the burden of users and caregivers

## Does not interfere with transferring to a wheelchair



## EB Coating

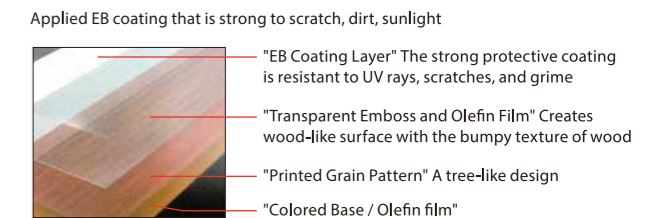

# Specifications

## 2 Motors, 3 Motors

### ● Resin Board

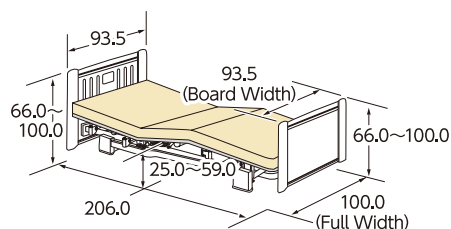

### ● Wooden Board

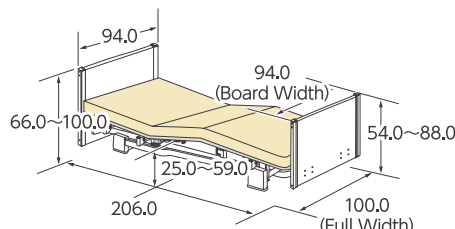

### ● Wooden Shelf Board

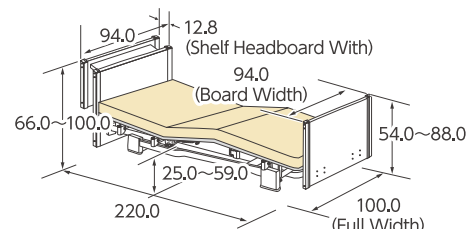

(Unit: cm)

\* Full width when using rail holder is 100.0cm

\* 8cm or over space at leg side and 1cm or over space at head side is necessary because the bed is moving up and down in arc

		2 Motors	3 Motors
Suitable Mattress Size		Length: 190.0 - 192.0cm, Width: 88.0 - 91.0cm Thickness: Max 18.0cm to Min 7.0cm	
Weight	Resin Board	Regular Size	77.0kg
	Wooden Board	Regular Size	81.0kg
	Wooden Shelf Board	Regular Size	89.5kg
Packing		5	
Material		Frame: Steel, ABS, PP / Resin Board: PE / Wooden Board: MDF Olefin board, Natural woods	
Angle Adjustment	Back Angle	0 - 70°	
	Knee Angle	0 - 22°	0 - 18°
Bottom Height		25.0 - 59.0cm With height raiser (PC501-FU45): +4.5cm With caster (PC503-8CK1): +3.5cm	
Voltage (Electricity Type)	Type-A	100VAC (50/60Hz)	
	Type-B	230VAC (50/60Hz)	
Power Consumption		100W	
Motor		Denmark LINAK	
Maximum Load Capacity for User's Weight		138kg / Safe load capacity: 174kg(1700N)	
Country of Manufacture		Vietnam	

## Optional Parts



### PC501-FU45

Miolet ForU, Miolet II  
45mm height raiser (4pcs)  
Material: PP  
Height in usage: +4.5cm



### PC503-8CK1

Miolet II Caster (4pcs)  
Material: Nylon, Polyurethane, Steel, ABS  
Height when using caster: +3.5cm  
\*4 pcs: 2 with stopper and 2 without stopper



### PE501-D40

Control Switch Holder  
Material: PP  
Dimension: length 21.7cm x width 7.6cm x height 5.3cm  
Weight: 60g



Usage Example



### PE500-A4050

Air Mattress Hanger  
Material: (Bar)POM, (Hook)ABS  
Dimension: length 33.5cm x width 10.5cm x height 12.5cm  
Weight: 420g  
Withstand load: 10kg



Usage Example